

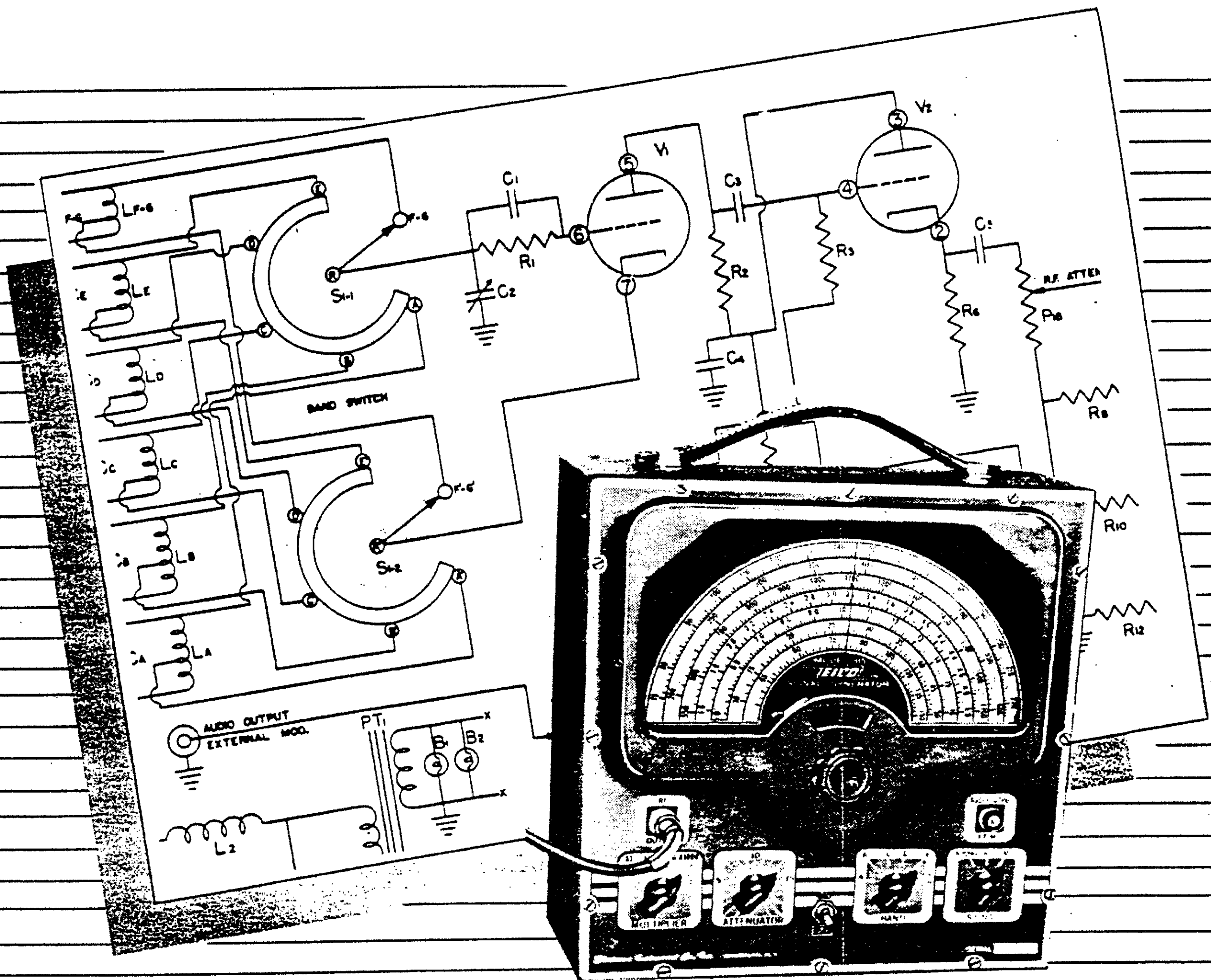

CONSTRUCTION MANUAL

Model 315

SIGNAL GENERATOR



ELECTRONIC INSTRUMENT CO., Inc.

CAPACITOR COLOR CODES

RMA 3-00 DR CODE FOR MICA-DIELECTRIC CAPACITORS

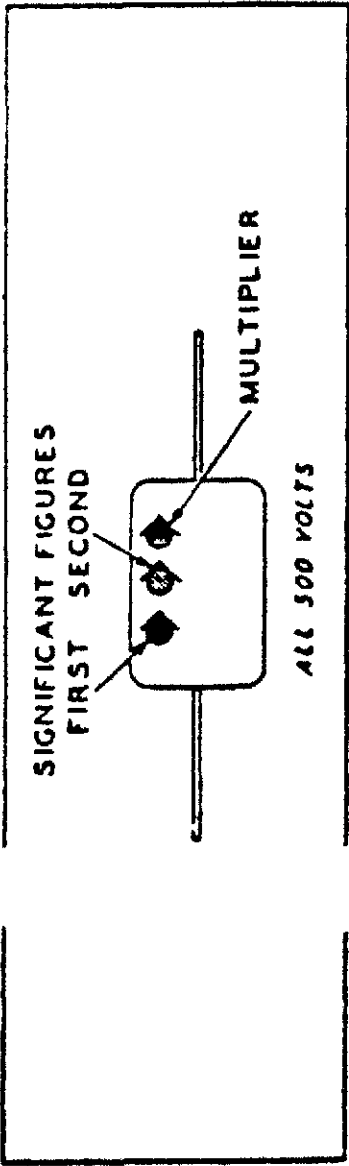

JAN 6-DOT COLOR CODE FOR PAPER-DIELECTRIC CAPACITORS

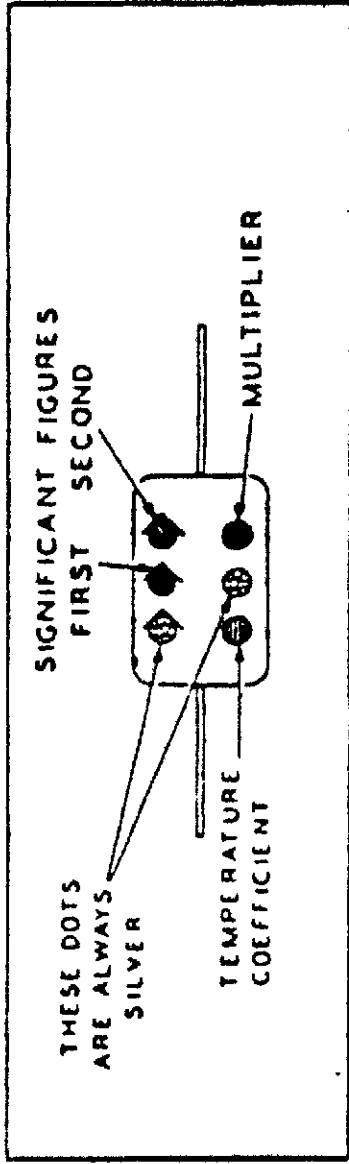

RMA 6-01 DR CODE FOR MICA-DIELECTRIC CAPACITORS

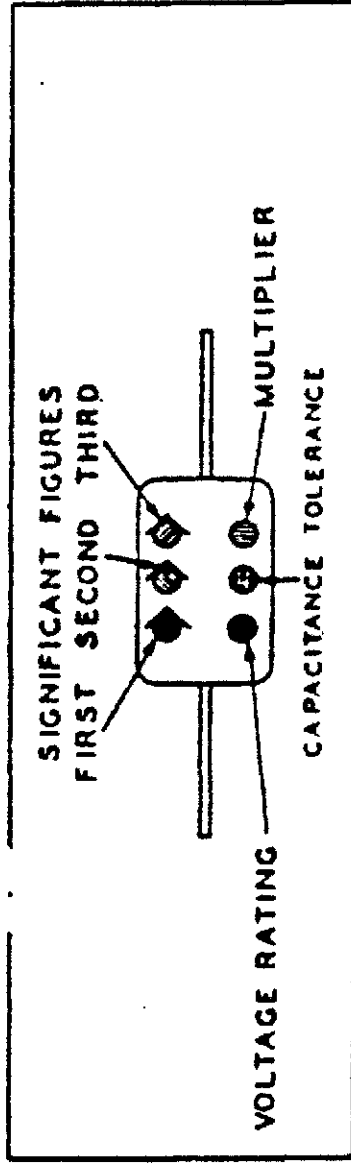

JAN 6-DOT COLOR CODE FOR MICA-DIELECTRIC CAPACITORS

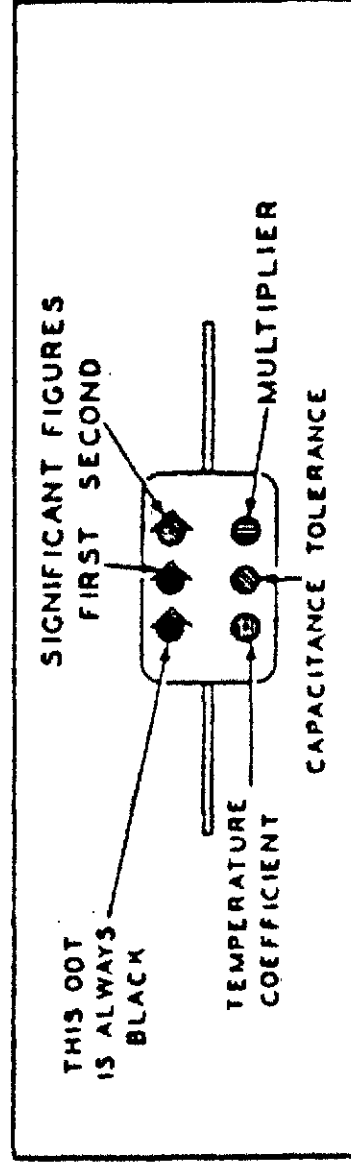

RMA COLOR CODE FOR TUBULAR CERAMIC-DIELECTRIC CAPACITORS

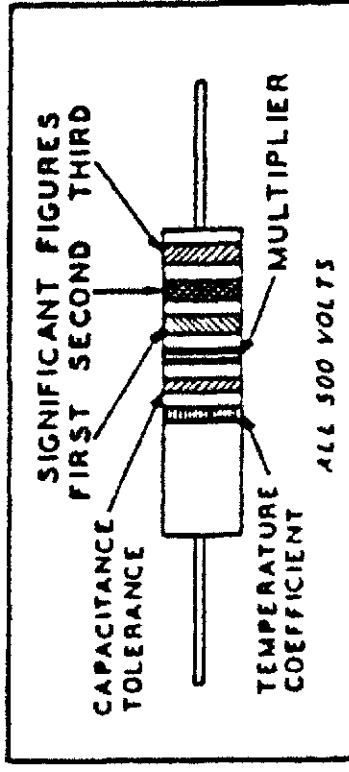

JAN COLOR CODE FOR FIXED CERAMIC-DIELECTRIC CAPACITORS

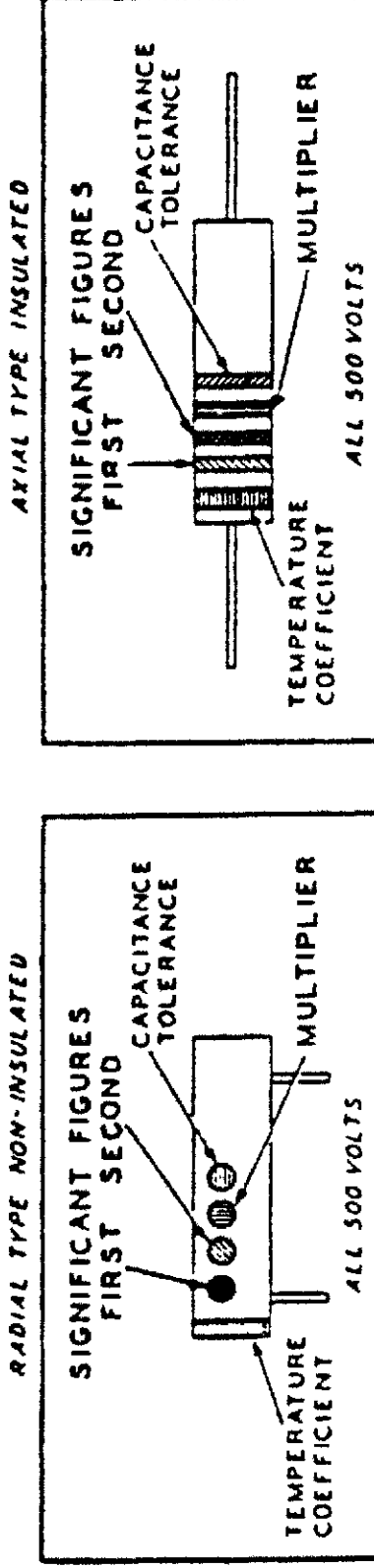

RADIAL TYPE NON-INSULATED

AXIAL TYPE INSULATED

RESISTORS

TOLERANCE	MULTIPLIER	SIGNIFICANT FIGURE	COLOR	RMA MICA AND CERAMIC-DIELECTRIC	JAN MICA AND PAPER-DIELECTRIC	JAN CERAMIC DIELECTRIC	VOLTAGE RATING	TEMPERATURE COEFFICIENT
5	0.1	0	BLACK	1	1	1	100	A
10	0.01	1	BROWN	10	10	10	200	B
20		2	RED	100	100	100	300	C
		3	ORANGE	1000	1000	1000	400	D
		4	YELLOW	10000			500	E
		5	GREEN	100000			600	F
		6	BLUE	1000000			700	G
		7	VIOLET	10000000		0.01	800	
		8	GRAY	100000000		0.1	900	
		9	WHITE	1000000000		1	1000	
			GOLD	0.1	0.1		2000	
			SILVER	0.01	0.01		500	
			NO COLOR					

CAPACITORS

RESISTORS		CAPACITORS						
TOLERANCE	MULTIPLIER	SIGNIFICANT FIGURE	COLOR	RMA MICA AND CERAMIC-DIELECTRIC	JAN MICA AND PAPER-DIELECTRIC	JAN CERAMIC DIELECTRIC	VOLTAGE RATING	TEMPERATURE COEFFICIENT
5	0.1	0	BLACK	1	1	1	100	A
10	0.01	1	BROWN	10	10	10	200	B
20		2	RED	100	100	100	300	C
		3	ORANGE	1000	1000	1000	400	D
		4	YELLOW	10000			500	E
		5	GREEN	100000			600	F
		6	BLUE	1000000			700	G
		7	VIOLET	10000000		0.01	800	
		8	GRAY	100000000		0.1	900	
		9	WHITE	1000000000		1	1000	
			GOLD	0.1	0.1		2000	
			SILVER	0.01	0.01		500	
			NO COLOR					

RMA: RADIO MANUFACTURERS ASSOCIATION
JAN: JOINT ARMY-NAVY

RESISTOR COLOR CODES

RMA COLOR CODE FOR FIXED COMPOSITION RESISTORS

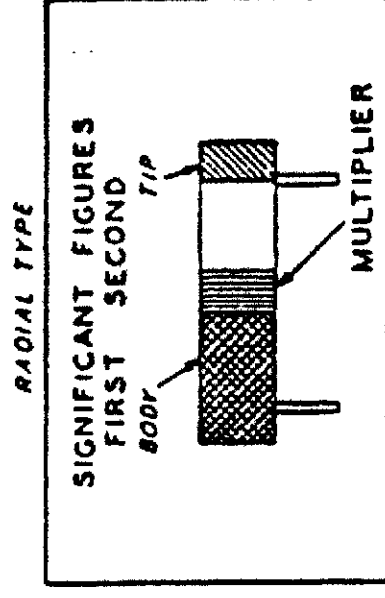
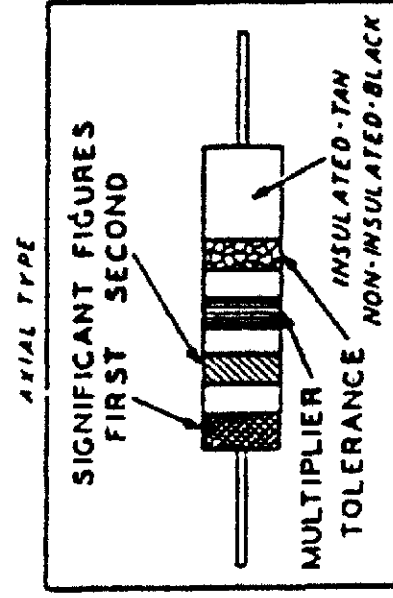

JAN COLOR CODE FOR FIXED COMPOSITION RESISTORS

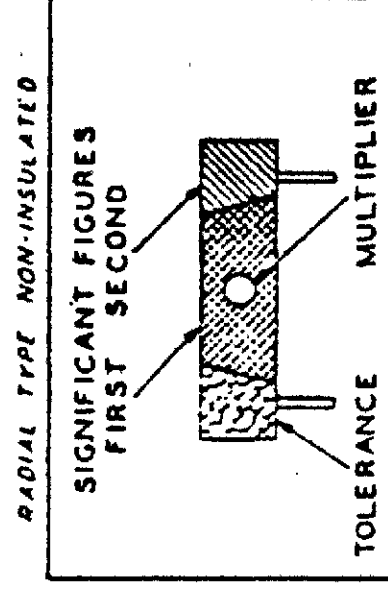
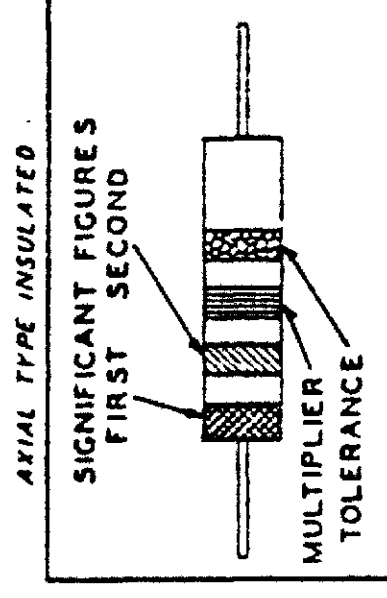

EICO MODEL 315K SIGNAL GENERATOR

The assembly of the Model 315 Signal Generator is not difficult; on the contrary, it is a simple and straight-forward series of steps. Each of these steps is geared to aid you in the rapid and intelligent completion of your instrument. Before starting the actual construction, study the schematic and pictorial wiring thoroughly getting all of the steps clear in your mind. Do not rush the assembly. Care will pay dividends. It is suggested, because of stray pickup and increased capacity by leads improperly run, etc. that you place your wiring exactly as shown on diagrams.

Note: Use a Good grade on rosin core Solder. **UNDER NO CIRCUMSTANCES USE ACID CORE SOLDER OR ACID FLUX** inasmuch as this can cause serious corrosion. Before soldering, make certain there is a good mechanical connection. The solder must flow before you remove the soldering iron. This will prevent rosin joints which are poor electrical conductors. If you are soldering close to a part, hold the ends of a pair of longnose pliers between the part and the solder joint. The pliers will conduct the heat away and prevent the component from being unduly overheated.

COMPONENTS

Carefully unwrap all the parts and check them in the space provided on the parts list. Note: In order to insure the supply of kits and prompt delivery, we are forced to order from several sources.. The standard manufacturers values may be interchangeable, etc. You may therefore find that a value may vary within the permissible circuit tolerance, e.g., a resistance of 470,000 ohms may be substituted for, or may measure 510,000 ohms, etc. All parts supplied will work just as well as the part for which it is substituted. Most parts have a tolerance rating of 20% and the circuit is designed to take these variations into account.

GENERAL INSTRUCTIONS

Construction Test and Calibration:- The construction of your instrument consists of five steps as follows:

- (a) Main Chassis Mounting and Wiring: The major chassis components are mounted and then wired.
- (b) Panel Wiring and Mounting: The panel is attached and wired to the chassis.
- (c) Coil Mounting and Wiring: The oscillator coils and their associated trimmer are mounted and wired onto the coil sub-chassis. The latter is then attached and wired to the main chassis.
- (d) Final Assembly: The insertion of the variable condenser, dial frame and vernier control completes the component assembly. The final wiring brings the instrument to ~~final~~ test and calibration stage.
- (e) Test: In this operation the tubes are inserted and preliminary tests made.
- (f) Calibration: The calibration procedure is a direct and simply formulated sequence using no unnecessary or "difficult to obtain" equipment.

PARTS LIST MODEL 315

Part#	Symbol	Description	Am't.	Part#	Symbol	Description	Am't.
92000	B1,B2	#47 bulb	2	53502	H29	pointer.....	1
22001	C1,C3	100 mmfd	2	57000	H30	line cord.....	1
29003	C2	main tuning cond...	1	58401	H31	coax cable.....	1
20001	C4,C8	.05 mfd cond.	2	51502	H33	crocodile clips	2
21000	C5	.001 mfd cond.	1	53000	H34	bar knobs	4
20004	C6	.25 mfd cond.	1	53004	H35	tuning knob	1
20005	C7	.5 mfd cond.	1	46000	H36	3/8 rubber grommet....	2
24000	C9,C10	10-10 mfd cond.	1	97701	H37	pilot light assem.	
20000	C11,C12	.01 mfd cond.	2			snap bracket	2
29504	CA-CE	trimmer cond. air		51000	H38	female connector	1
		4-24 mmf	5	42005	H39	#6 flat washer	4
29500	CFG	3-12 mmf hi-freq.		97003	H40	octal socket	3
		trimmer cond.	1	97002	H42	7 pin miniature socket	1
30003	H1	panel	1	34500	L1	audio choke	1
36000	H2	C.I. molded frame..	1	35003	L2,L3	line filter	1
31003	H3	chassis	1	35000	LABC	low frequency coil ..	1
31004	H4	chassis bot. plate.	1	35001	LDE	middle freq. coil....	1
31005	H5	attenuator box and		35002	LFG	high frequency coil..	1
		cover	1 ea.	18004	P1	1K-250K dual pot ...	1
31006	H6	coil sub-chassis ..	1	30002	PT1	power transformer ...	1
38000	H7	cabinet	1	10018	R1,R4	22K ohm 1/2W	2
37004	H8	handle	1	10006	R2	510 ohm 1/2W	1
39527	H8	handle holders	2	10030	R3	1 meg ohm 1/2W	1
31002	H9	#6 self-tap. screw	26	10023	R5	68K ohm 1/2W	1
31000	H10	6-32X1/4 H.R.H. ...	18	10016	R6	10K ohm 1/2W	1
33001	H11	pot grounding lugs.	3	10015	R7,9,11	1000 ohm 1/2W	3
31011	H12	4-40X3/16 M.S. ...	10	10003	R8,10,	100 ohm 1/2W	3
31008	H14	6-32X1/2 H.R.H. ..	4		R12		
31021	H15	3-48X1/8 R.H. MS ..	1	14000	R13	6K ohms, 10 W axial	
30000	H16	6-32 hex nuts	17			lead	1
	H17	construction book..	1	10802	R14	1K ohms, 1W	1
	H18	instruction book...	1	60003	S1	2P-6pos switch	1
20001	H19	3/8 flat washer ...	4	60000	S2	2P-3pos switch	1
20002	H20	#6 lock washer	19	60004	S3	1P-4pos switch	1
30002	H21	15/32-32 tog. nut..		61000	S4	SPST switch, toggle..	1
		hex	1	54007	T1	3 post terminal post	
30003	H21	15/32-32 ring nut..	1			with grnd.	1
30001	H22	3/8 nuts hex	4	54003	T2,T3	2 post term. post ...	2
32000	H23	3/8 lock washer....	4	90002	V1	6C4 tube	1
33000	H24	gnd lugs, #6	5	90007	V2	6SL7 tube	1
35001	H25	bare wire	2 ft.	90014	V3	VR150 tube	1
36000	H26	hook-up wire	24ft.	90009	V4	6X5 tube	1
37000	H27	connector jacks ...	2	59500	C9,C10	mounting plate for	
39503	H28	0-100 micro scale..	1			condenser	1
33300		spaghetti... 1 1/2 ft.					

M.S. Machine Screw; H.R.H. - Half Round head screw

NOTE: When ordering replacement parts, please include all of the following information: 1) stock number and description given in parts list; 2) quantity; 3) model number of instrument; 4) serial number of instrument(on panel). This information will expedite the processing of your order and insure your receiving the correct replacement parts.

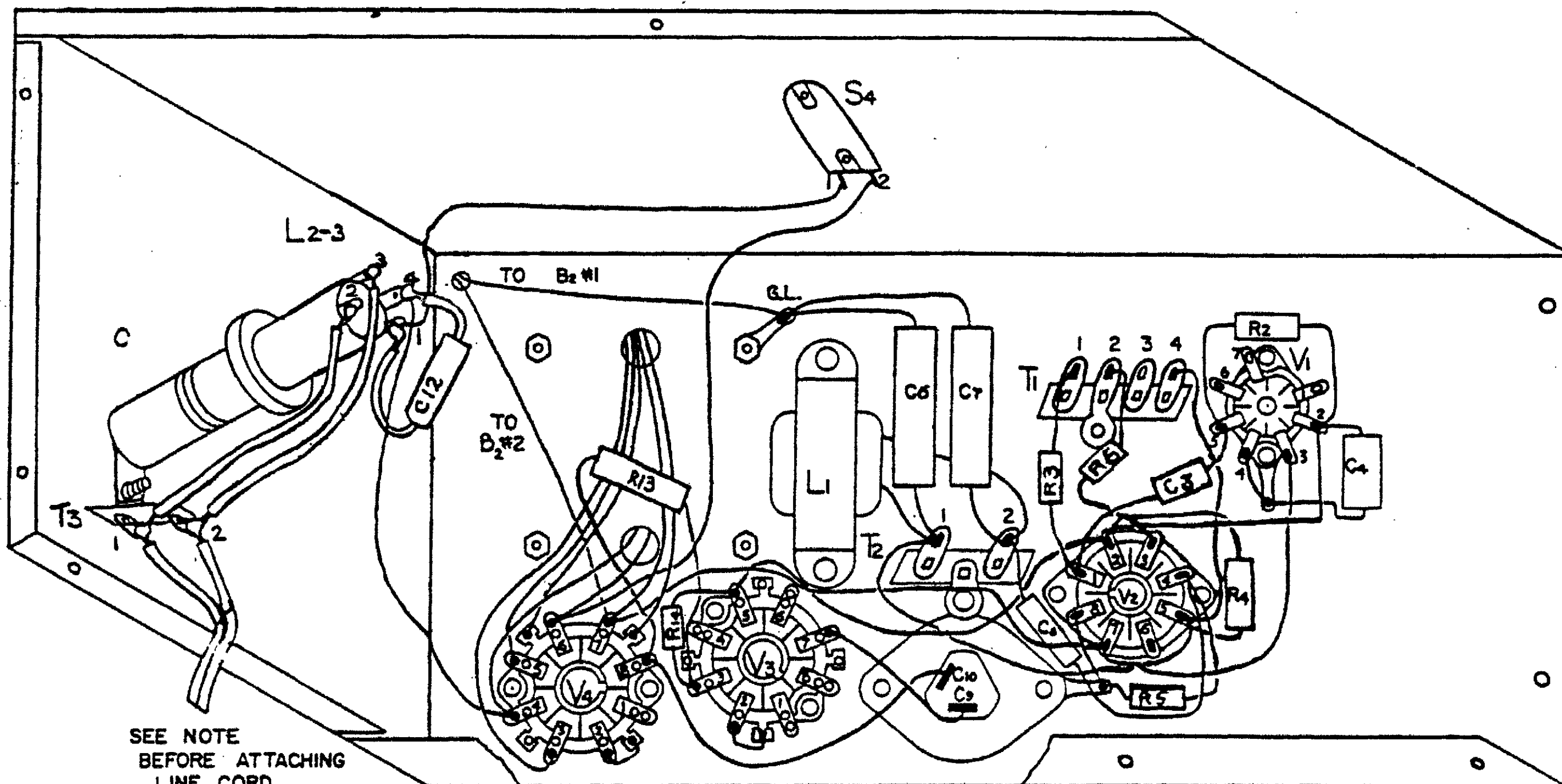

MAIN CHASSIS MOUNTING AND WIRING

ASSEMBLY PRINT NO.1 MODEL 315 SIGNAL GENERATOR

MAIN CHASSIS MOUNTING INSTRUCTIONS

CHK	SYMBOL	DESCRIPTION	MOUNTED WITH	LOCATION
	PT1	Power transformer	4#H20, 4#H16, 4#H10, 1#H24, 4#H3C	See diagram
	L1	Audio choke	2#H20, 2#H16, 2#H10	
	T1	3 post terminal strip	1#H20, 1#H16, 1#H10	
	T2	2 post terminal strip	1#H20, 1#H16, 1#H10	
	L2-L3	Line filter	1#H10, T3	
	S4	SPST switch	1 ea type H21	Temporary mount
	C9, C10	Dual 10 mfd.		Twist lugs

In the wiring instructions (C) means "connect" and (S) means "solder". As an example, consider the first line of the following instructions: The black lead of the power transformer (PT1) is "connected" to pin #6 of tube V4. Another example would be the 10th line: A .01 mfd condenser, C12, is soldered from pin #4 of coil L2-3; the other side is connected to pin #1 of coil L2-3.

MAIN CHASSIS WIRING INSTRUCTIONS

SYMBOL	DESCRIPTION	FROM	TO	REMARKS
PT1	Power transformer	Black	V4#6(C)	
PT1	Power transformer	Black	V4#4(C)	
PT1	Power transformer	Red	V4#5(S)	
PT1	Power transformer	Red	V4#3(S)	
PT1	Power transformer	Yellow	V4#7(C)	
PT1	Power transformer	Yellow	Gnd lug(S)	Lug on socket
PT1	Power transformer	Red-yellow	Gnd lug(S)	Lug on socket
H25	Bare wire	(S)V4#2	Gnd lug(S)	
H26	Hook up	(S)V4#4	L2-3#4(C)	See note
C12	.01 Mfd.	(S)L2-3#1	L2-3#1(C)	
H26	Hook up	(S)L2-3#1	S4#1(S)	
R13	6K 10 watt	(C)V4#8	V3#3(C)	
R14	1K ohms 1 watt	(S)V3#3	V3#5(C)	
H26	Bare wire	(S)V3#2	Gnd lug(S)	Lug on socket
H26	Hook up	(S)V4#8	C10(S)	
H26	Hook up	(S)C9	V3#7(S)	
H26	Hook up	(S)V3#5	V2#2(C)	
H26	Hook up	(C)V4#7	V2#7(C)	
H26	Hook up	(C)V2#2	V2#5(C)	
R4	22K	(C)V2#1	(C)T2#1	
L1	Audio choke	Lead of choke	(C)T2#1	
L1	Audio choke	Other lead	T2#2(C)	
C7	.5 Mfd.	(C)T2#2	Q1(C)	
C6	.25 Mfd.	(C)T2#1	Q1(C)	
C8	.05 Mfd.	(S)T2#2	V2#4(C)	
R5	68K	(C)GL	V2#4(S)	
H25	Bare wire	(S)V2#8	Q1(S)	
R6	10K	(C)V2#3	T1#2(C)	
		(C)V1#2	GL(C)	
		(C)V1#5	V1#2(C)	
		(C)V2#1	V1#5(S)	
R3	1 meg	(S)V2#1	T1#1(C)	
H26	Hook up	(S)V1#3	V2#7(S)	
H26	Hook up	(S)T2#1	V2#5(C)	
H25	Bare wire	(S)V1#4	Q1(S)	
H26	Hook up	(S)V1#2	V2#2(S)	
H26	Hook up	(S)V4#6	S4#2(S)	
H26	Hook up	(C)T1#4	V2#5(S)	
H26	Hook up	(S)V4#7	12 in.	Thru chassis hole
H26	Hook up	(S)GL	12 in.	Thru chassis hole
H26	Hook up	(C)T3#1	L2-3#2(S)	
H26	Hook up	(C)T3#2	L2-3#3(S)	
H30	Line cord	One lead	T3#1(S)	See note
H30	Line cord	Other lead	T3#2(S)	See note

Note: Mount 3/8 rubber grommet, H36, on per assembly print #5. Pass line cord thru grommet and knot eight (8) inches from end.

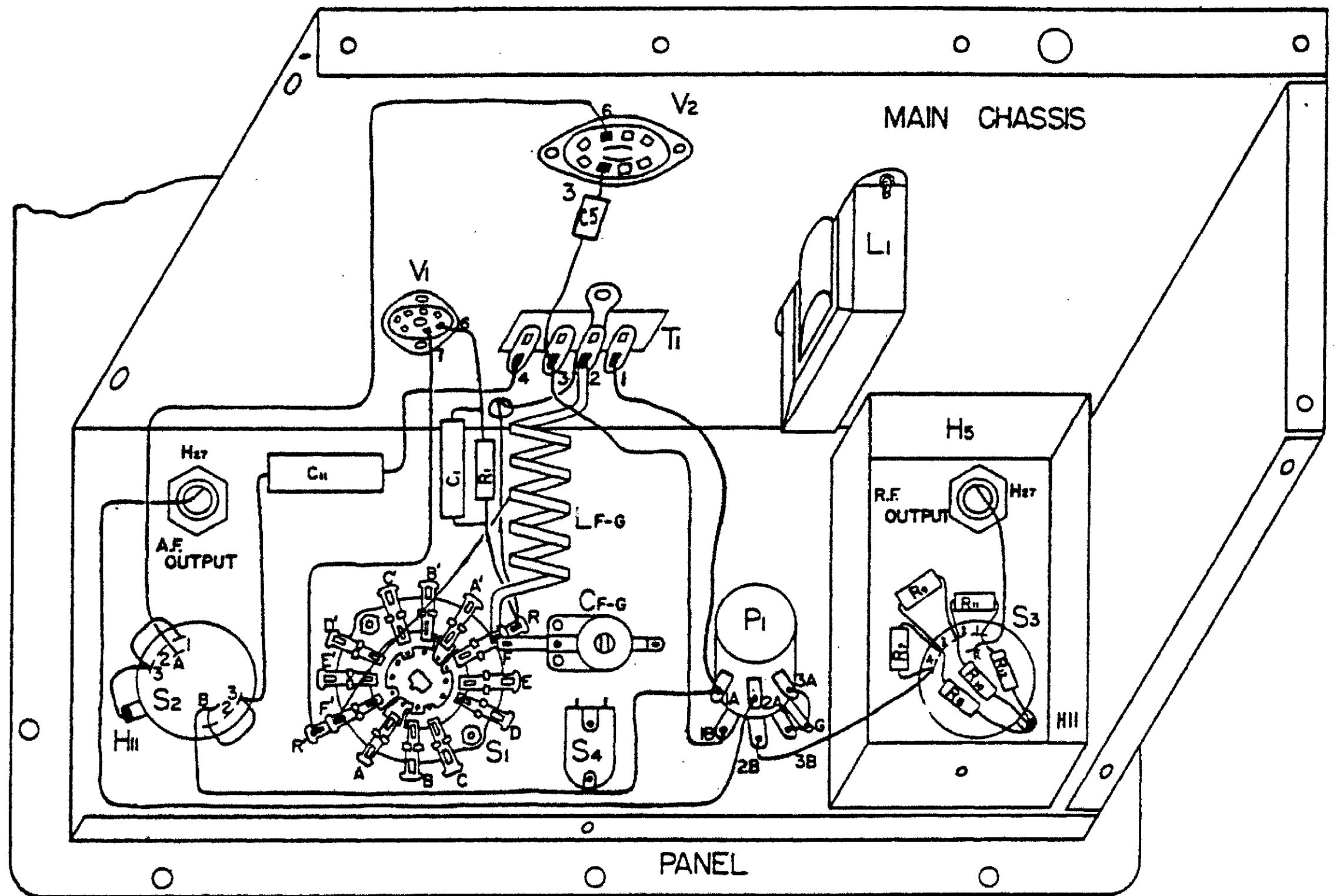

PANEL MOUNTING AND WIRING

ASSEMBLY PRINT NO. 2 MODEL 315 SIGNAL GENERATOR

PANEL MOUNTING INSTRUCTIONS

chk	Symbol	Description	Mounted With	Remarks
	S4	On-Off Switch	2 #H21	Remove S4 from chassis and then remount with panel attached to chassis with S4
	S2	2P-3 pos. switch	1 #H22, 1 #H19, 1 #H11	Orient switch as shown
	S1	2P-6 pos. switch	1 #H22, 1 #H19	"
	P1	1K- 250K Dual Pot	1 #H23, 1#H22 1 #H19, 1#H11	"
	S3	1 p.- 4 pos. switch	1 #H22, 1#H19, 1 #H11	H5 is mounted under switch in position shown
	H27	Audio connector jack	Attached nut, H23	
	H27	R.F. Connector jack	Attached nut, H23	Mount thru H5

PANEL WIRING INSTRUCTIONS

Chk	Symbol	Description	From	To	Remarks
	H26	Hook up wire	(S)V2#6	S2#A(S)	
	H25	Bare wire	(S)S2#1A	S2#3A(C)	
	H25	Bare wire	(S)S2#3A	H11(S)	
	H25	Bare wire	(S)S2#1B	S2#3B(C)	
	C11	.01 Mfd.	(S)S2#3B	T1#4(S)	Spaghetti
	H26	Hook up wire	(S)T1#1	F1#1A(C)	
	H26	Hook up wire	(S)S2#B	F1#1A(S)	
	H26	Hook up wire	(S)F1#1B	T1#3(C)	
	C5	.001 mfd cond	(S)T1#3	V2#3(S)	
	H25	Bare wire	(S)F1#3A	H11(C)	
	H25	Bare wire	(S)F1#3B	H11(S)	
	H26	Hook up wire	(S)F1#2B	S3#4(C)	
	R7	1000 ohms	(S)S3#4	S3#3(C)	
	R8	100 ohms	(C)S3#3	H11(C)	
	R9	1000 ohms	(S)S3#3	S3#2(C)	
	R10	100 ohms	(C)S3#2	H11(C)	
	R11	1000 ohms	(S)S3#2	S3#1(C)	
	R12	100 ohms	(S)S3#1	H11(S)	
	H26	Hook up wire	(S)S3#R	R.F. Jack(S)	See insert
	H26	Hook up wire	(S)F1#2A	A.F. Jack(S)	See insert
	LFG	H1 freq.coil	(C)S1#F	T1#2(C)	In positio
	H26	Hook up wire	(S)T1#2	Thru hole	6 inches
	LFG	H1 freq.coil	(S)Tap	S1#F(S)	
	R1	22K ohms	(C)V1#6	S1#R(C)	
	C1	100 Mafd cond	(S)V1#6	S1#R(C)	
	H26	Hook up wire	(S)S1#R	Thru hole	6 inches
	H26	Hook up wire	(S)V1#7	S1#R(S)	
	CP0	H1 freq.trim.	(S)S1#F	Ond(S)	As show

CONNECTOR MOUNTING

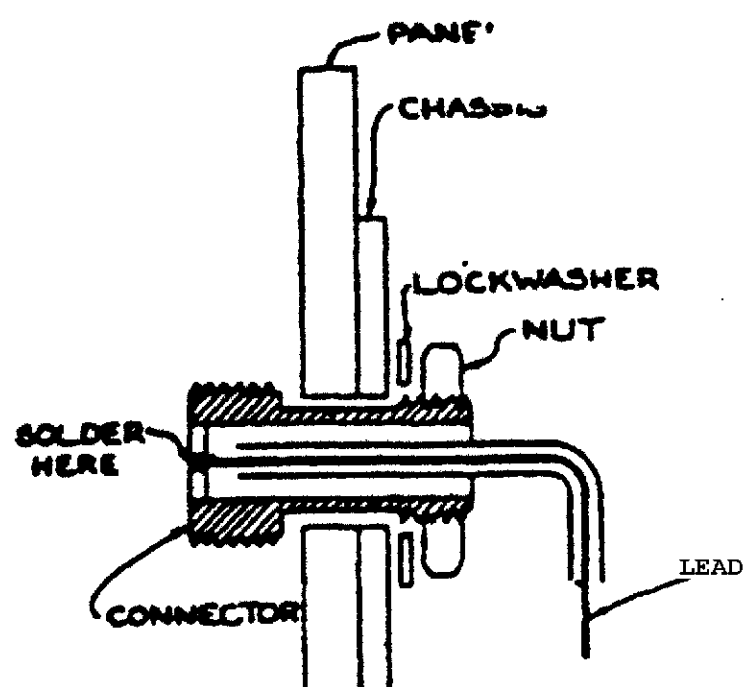

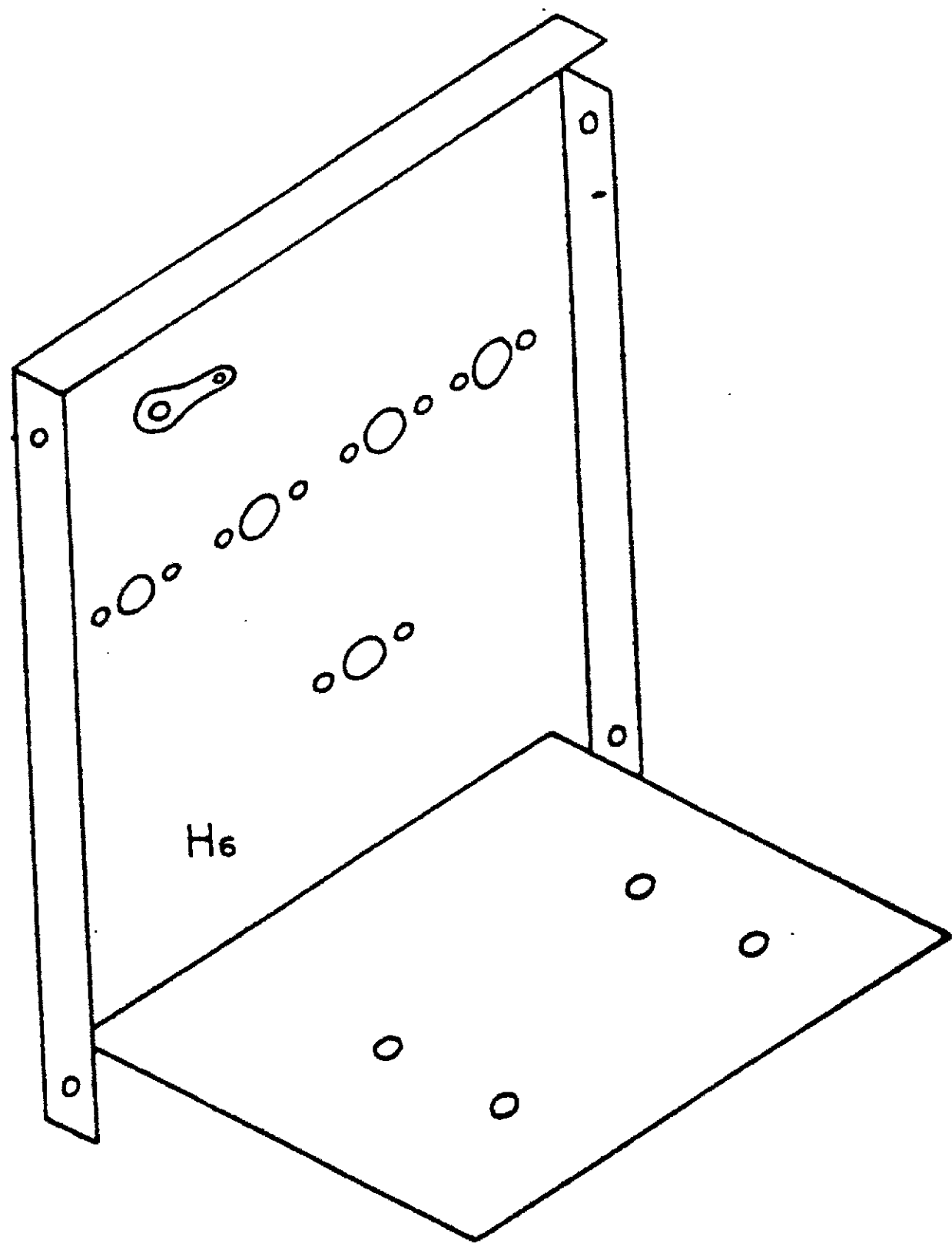

COIL AND CONDENSER SUB-CHASSIS

SUB-CHASSIS MOUNTING INSTRUCTIONS

Chk	Symbol	Description	Mounted With	Location
	CA	Air Trimmer	2#H12	See Diagram
	CB	"	"	"
	CC	"	"	"
	CD	"	"	"
	CE	"	"	"
	LABC	Coil Assembly	2#H16, 2#H20	Right Hand Side
	LDB	Coil Assembly	2#H16, 2#H20	Left Hand Side

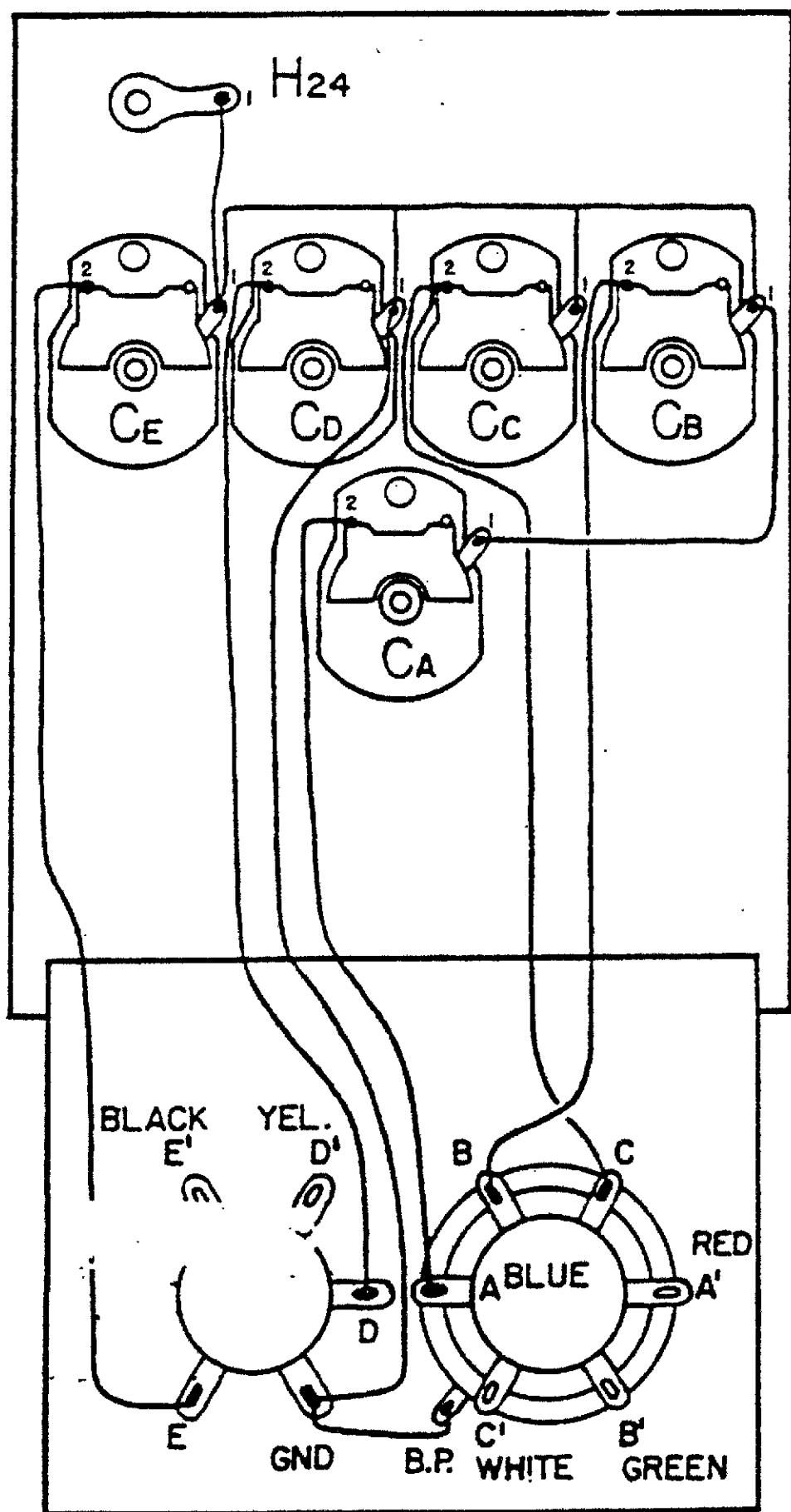

COIL AND CONDENSER MOUNTING AND WIRING

SUB-CHASSIS WIRING INSTRUCTIONS

Chk	Symbol	Description	From	To	Remarks
	H25	Bare Wire	(S) CA#1	CB#1 (C)	Slack Wire
	"	"	(S) CB#1	CC#1 (C)	
	"	"	(S) CC#1	CD#1 (C)	
	"	"	(C) CD#1	CE#1 (C)	
	"	"	(S) CE#1	H24#1 (S)	
	"	"	(S) CA#2	Coil A (C)	
	"	"	(S) CB#2	Coil B (C)	
	H26	Hook Up	(S) Coil B	6 inches	
	H25	Bare Wire	(S) CC#2	Coil C (C)	
	H26	Hook Up	(S) Coil C	6 inches	
	H25	Bare Wire	(S) CD#2	Coil D (C)	
	H26	Hook Up	(S) Coil D	6 inches	
	H25	Bare Wire	(S) CE#2	Coil E (C)	
	H26	Hook Up	(S) Coil E	6 inches	
	H25	Bare Wire	(S) CD#1	GND (C)	
	"	"	(S) GND	Bottom Pin(s)	

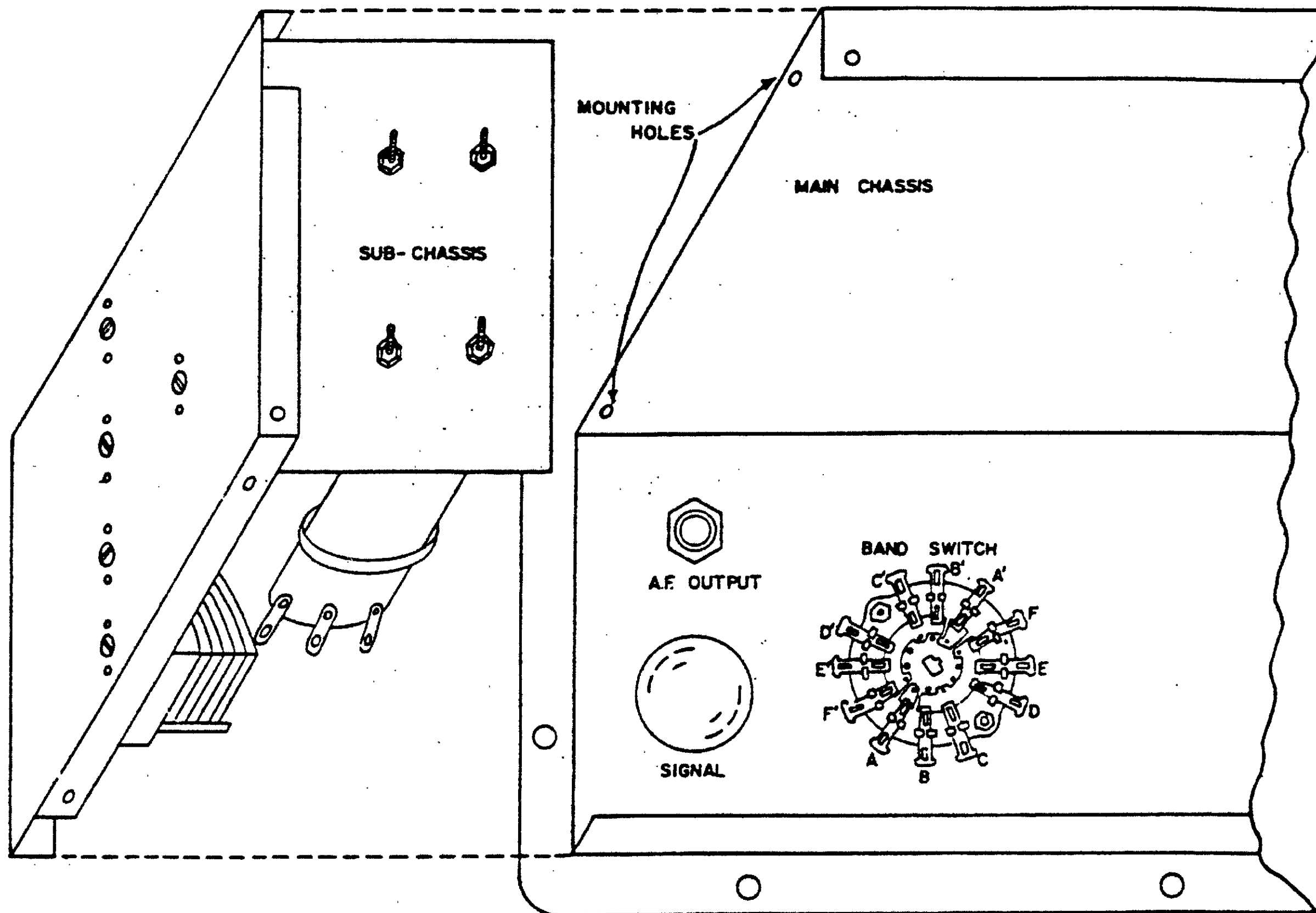

SUB-CHASSIS MOUNTING

SUB-CHASSIS MOUNTING

Chk	Symbol	Description	Mount with	Remarks
	H6	Wired sub-chassis	2#H9	See Diagram

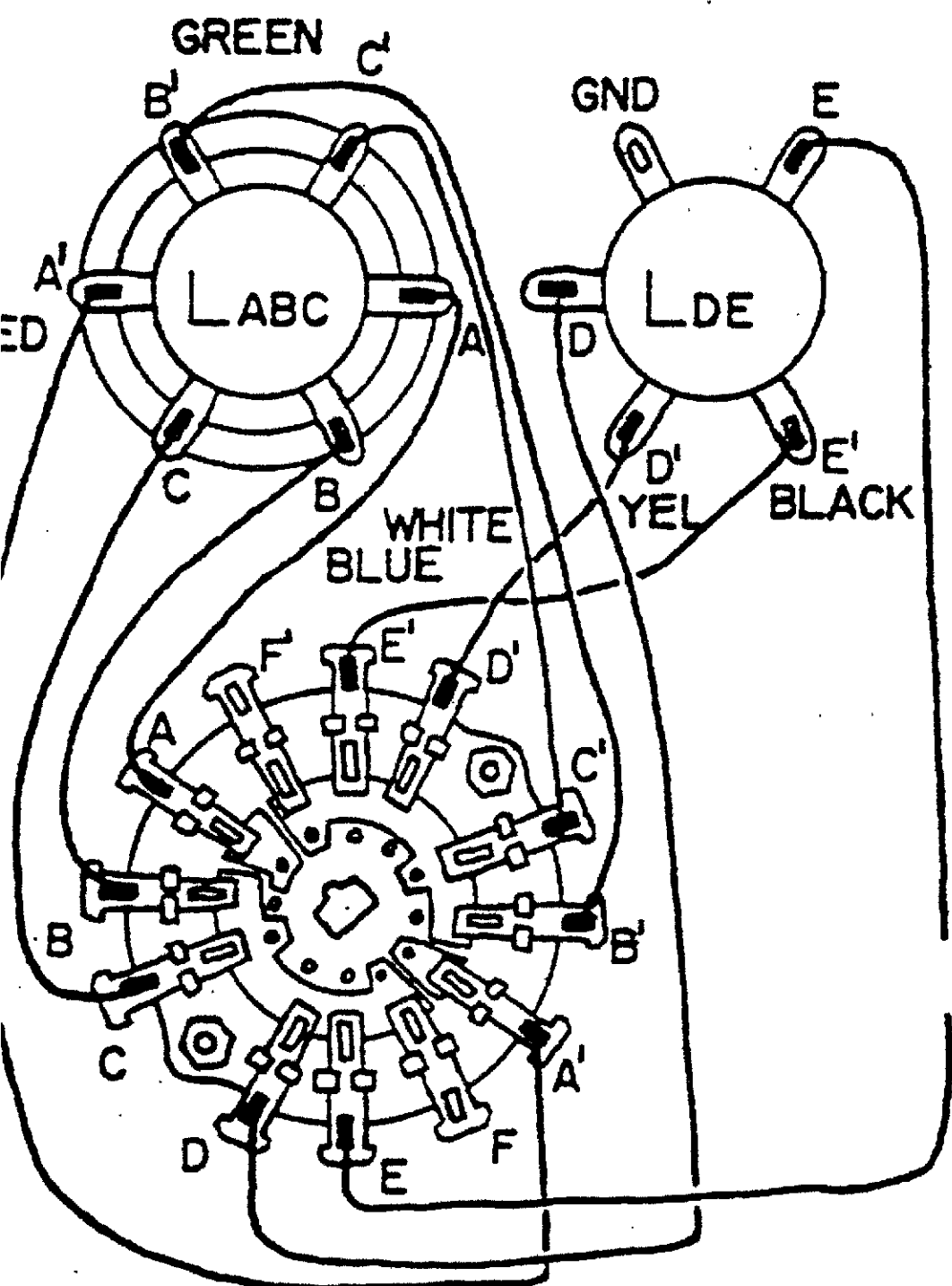

BAND SWITCH WIRING

Rotate chassis (clockwise 90 degrees) so that switch and chassis are aligned as shown in diagram to left.

BAND SWITCH WIRING

Chk	Sym.	Descrip.	From	To	Remarks
	H26	H.U. Wire	LABC#A	S1#A	Blue
			LABC#B	S1#B	Attached wire
			LABC#C	S1#C	"
			LABC#A'	S1#A'	Red
			LABC#B'	S1#B'	Green
			LABC#C'	S1#C'	White
			LDE#D	S1#D	Attached wire
			LDE#E	S1#E	"
			LDE#D'	S1#D'	Yellow
			LDE#E'	S1#E'	Black

NOTE : SOLDER ALL CONNECTIONS

ASSEMBLY PRINT NO.5 MODEL 315 SIGNAL GENERATOR

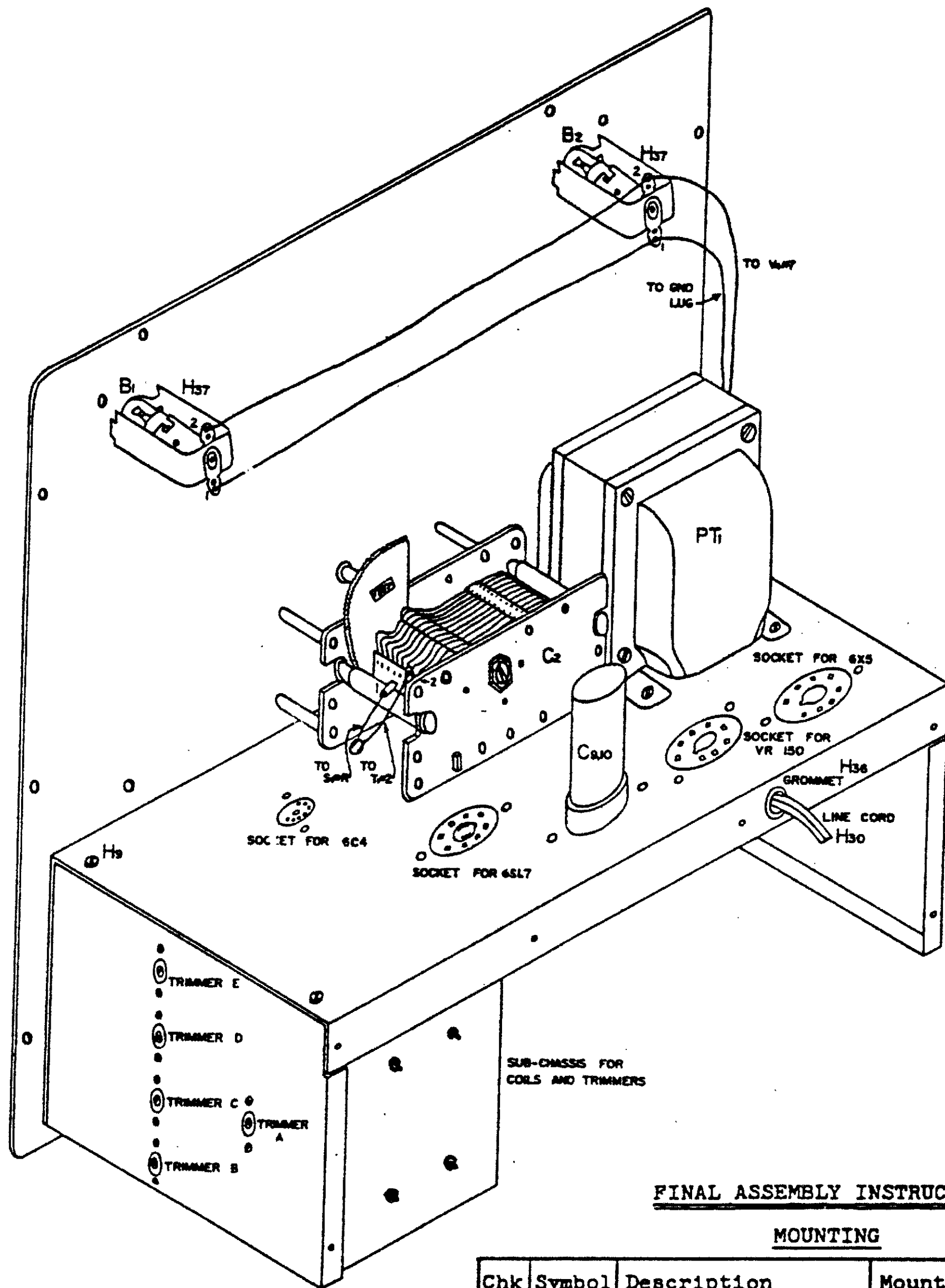

FINAL ASSEMBLY INSTRUCTIONS

MOUNTING

Chk	Symbol	Description	Mounted With	Remarks
	C2	Main tuning cond.	4 #H10	Keep cond. closed With B1 and B2
	H37	Pilot light socket	Snap in	

WIRING

Chk	Symbol	Description	From	To	Remarks
	H26				
	"	"	*G.L.	B2#1(C)	
	"	"	(S)B2#1	B1#1(S)	
	"	"	**S1#R	C2#1(S)	
	"	"	**T1#2	C2#2(S)	

* Main Chassis Wiring

** Panel Wiring

With large shaft turned fully clockwise, screw pointer H29 to small shaft with small screw H15. Line pointer along blue line on extreme left side of scale. Slide the micro scale, H28, onto the large shaft. With the shaft turned fully clockwise, tighten the set screw on the micro-scale H28 so that the zero mark is in a vertical position. The molded frame H2 with attached glass is now placed on the panel and secured with 4 #H14 screws in the holes provided. The tuning knob, H35, is attached to the large shaft and the 4 Bar Knobs H34 are attached to respective shafts. Using parts H31, (shielded cable), H33, (alligator clips), and H38, (female connector), construct coaxial cable as shown in insert drawing.

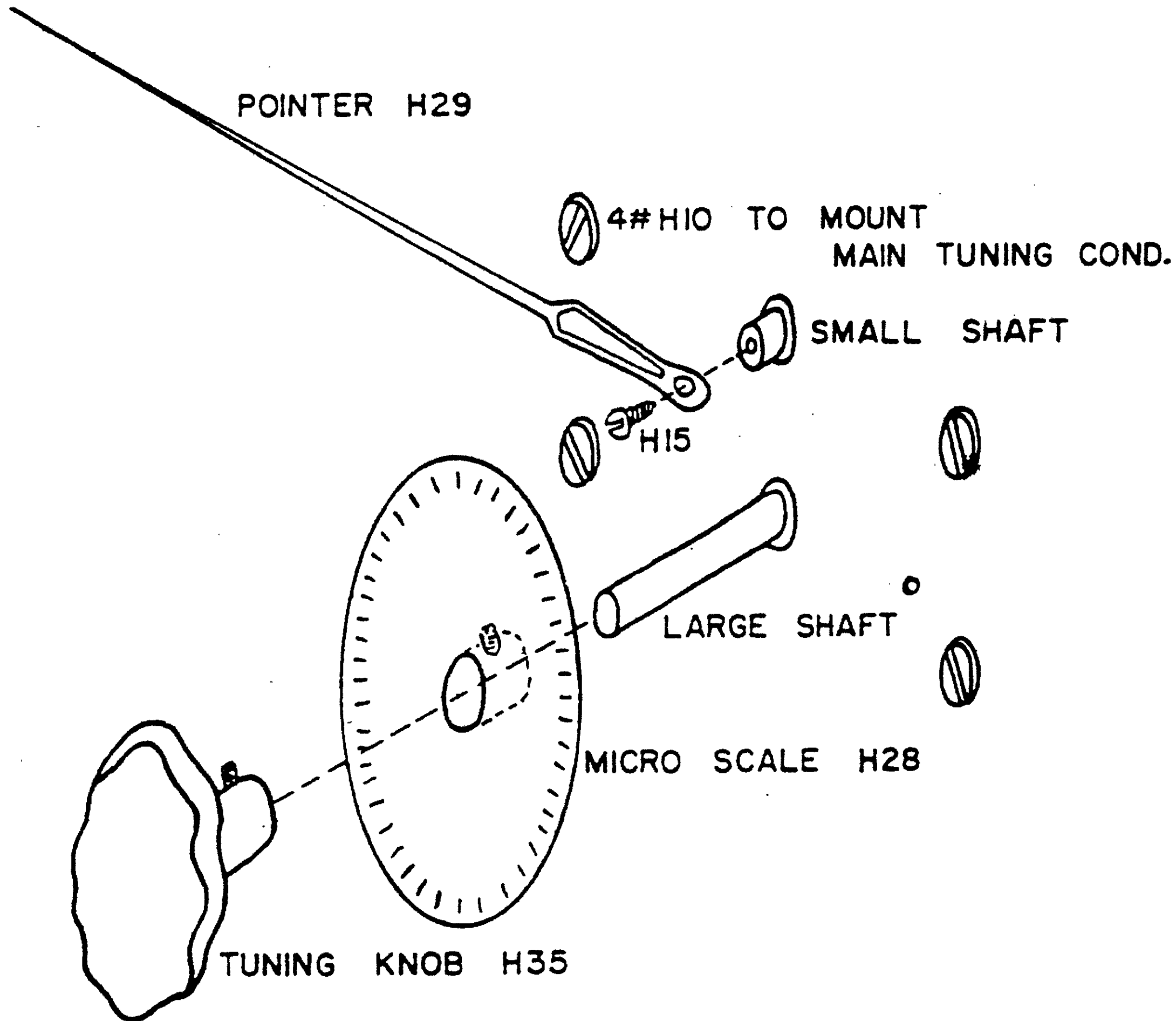

POINTER AND KNOB ASSEMBLY

COAXIAL CABLE ASSEMBLY

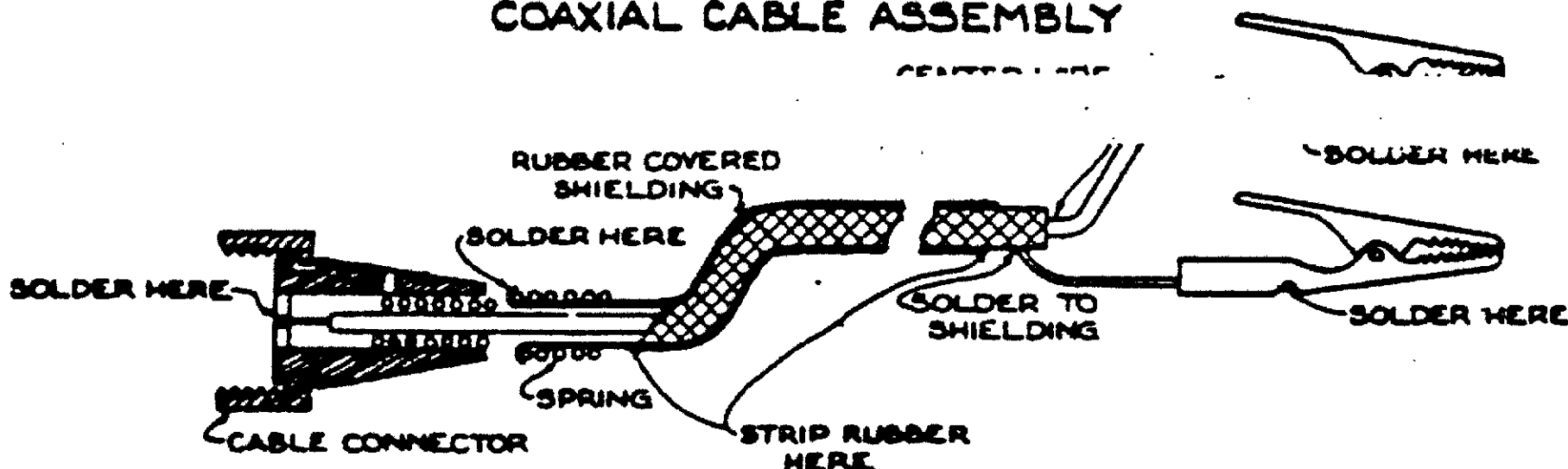

FINAL STEPS

You have now completed the mechanical assembly of your signal generator. A few more steps and simple precautions at this point and the instrument may be turned on and calibrated.

1. Insert tubes in sockets: See assembly print #5 for tube locations.
2. Measure the resistance from B (Pin #8 of 6X5 to ground). This should be over 500,000 ohms. If it is lower, recheck B+ circuit before continuing, but under no circumstances apply power until the error has been located.
3. Insert line cord and turn set on. The dial lights and tubes should light immediately. If not, turn set off and check the filament circuit. Do not leave power on as this could damage the power transformer. The VR tube (VR 150) should light within 30 seconds. If not, recheck B+ circuit.

Calibration:- The simplest and most accurate calibration procedure that we have found to date is Signal Comparison with another signal generator. In this system a circuit as shown in Figure 1 is wired.

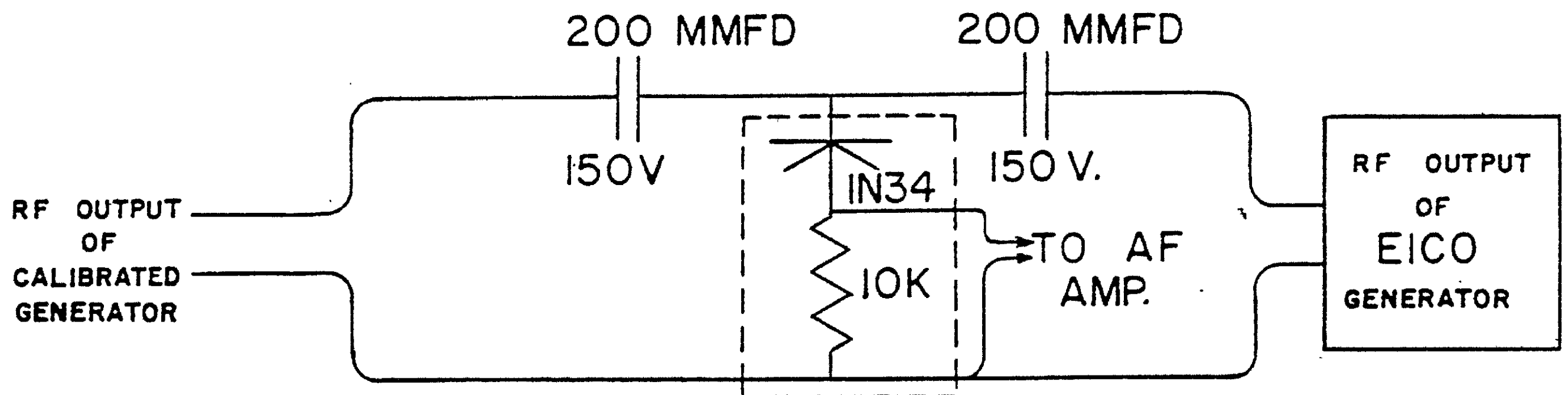

FIGURE 1

Note: If desired, an oscilloscope or earphones may be substituted for the AF amplifier; an RF probe (EICO Model PD Probe) may be substituted for the dotted area.

1. Turn both signal generators "on". Allow about 15 minutes for initial "warm-up".
2. Set both RF outputs to maximum. (EICO: MULTIPLIER to X1000; ATTENUATOR to 20; SIGNAL to RF; BAND to A).

3. Set both generators to 200KC and adjust the BAND A trimmer for "zero-beat".* (See assembly print #5 for location of trimmers).
4. Set the Model 315 Signal Generator to 550KC on BAND B. Set the other signal generator to 550KC and adjust the BAND B trimmer for zero-beat.
5. Set the Model 315 Signal Generator to 1600KC on BAND C. Set the other signal generator to the same frequency and adjust the BAND C trimmer for "zero-beat".
6. Set the Model 315 Signal Generator to 5mc on BAND D. Set the other signal generator to the same frequency and adjust the BAND D trimmer for "zero-beat".
7. Set the Model 315 Signal Generator to 15mc on BAND E. Set the other signal generator to the same frequency and adjust the BAND E trimmer for "zero-beat".
8. Set the Model 315 Signal Generator to 50mc on BAND F. Set the other signal generator to the same frequency and adjust the BAND F trimmer (located under chassis- See assembly print #2, part #CF-G) for "zero-beat". The whistle at this step may be somewhat erratic due to the high frequencies involved.
9. This completes the approximate alignment of the signal generator. The following procedure may be used for a very accurate alignment.
 - A) Feed the RF output of the 315 Signal Generator through a 200 mmfd condenser to the antenna of a receiver. Ground the braided alligator clip to the receiver chassis.
 - B) Tune the receiver to a station between 500KC and 600KC.
 - C) With the station still coming in, set the 315 Signal Generator on BAND B to the same frequency as the station. Reduce the MULTIPLIER to a lower setting if the station is drowned out. Adjust the BAND B trimmer for "zero-beat" on the receiver. This should only be a very slight adjustment since the range was already approximately set with the other generator.
 - D) Set the 315 Signal Generator on BAND A to $1/3$ the frequency being received on the receiver. Adjust the BAND A trimmer for "zero-beat".
 - E) Tune the receiver to a station between 1400KC and 1700KC. Set the 315 Signal Generator on BAND C to the same frequency as the station. Adjust the BAND C trimmer for "zero-beat".

Zero-beat is the point where the whistle gradually decreases in pitch and is heard. The whistle will be high pitched and will gradually decrease until no sound is heard and finally, if the rotation is continued in the same direction, it will gradually increase in pitch. The center position (between the 2 high pitched notes) where no sound is heard is the "zero-beat" point.

F) Tune an all-wave receiver to some frequency in the neighborhood of 5mc. (WWV, the government station broadcasts on frequencies of 2.5mc, 5mc, 10mc, 15mc, 20mc and 25mc. This is one of the most accurate sources of calibration in the world). Note: If an all-wave receiver is not immediately available, this portion of the calibration may be temporarily deferred since the instrument was approximately aligned with the other signal generator.

Set the 315 Signal Generator to the same frequency as that being received on the receiver. Adjust the BAND D trimmer for "zero-beat".

G) Tune the receiver to some frequency in the neighborhood of 15mc. Adjust the 315 Signal Generator to the same frequency on BAND E as that being received on the receiver. "Zero-beat" with the BAND E trimmer.

H) Tune the receiver to some frequency in the neighborhood of 25mc. Adjust the 315 Signal Generator to the same frequency on BAND F as that being received on the receiver. "Zero-beat" with the BAND F trimmer. (This also calibrates BAND G).

This completes the alignment of your signal generator. It's accuracy should be extremely high and should not require recalibration for many years to come.

Cabinet: Secure handle to cabinet with 4 #6/32 screws, nuts and lock-washers.

Shields: Slip RF shield onto H5 over switch S3, (See assembly print #2) and secure cover with #6 self tapping screw (H9) on bottom. The top is located with a small indent. Make certain the wires fit into slot. Cover entire back of chassis with chassis bottom plate H4 and secure with 11, #6/32 (H9) self tapping screws.

Panel: Thread line cord through elliptical hole in cabinet. Secure panel to cabinet with 12, #6/32 self tapping screws (H9).

In the event of trouble:

1. Check all voltages.
2. Check individual components for improper wiring or breakdown.
3. Recheck the wiring procedure. Nearly all our cases of trouble in the past have improper wiring as their cause:
4. If you are still having difficulty, write to our Engineering Dept. (Dept. SG) listing all voltages and whatever other indications you have which might be of help.
5. If desired, you may return the instrument to the factory where it will be calibrated and placed in operating condition for a charge of \$5.00 plus any part or alterations required due to damage in construction. Ship with tubes packed separately in the original shipping carton if possible. Pack unit very carefully and send prepaid Railway Express. The generator will be returned as soon as possible Express collect.

SYMBOL	PART	# SPECIFICATION
B1	1	#47 bulb
B2	1	#47 bulb
C1	2	100 mmfd cond.
C2	3	Main tuning cond.
C3	2	100 mmfd cond.
C4	4	.05 mfd cond.
C5	5	.001 mfd cond.
C6	6	.25 mfd cond.
C7	7	.5 mfd cond.
C8	4	.05 mfd cond.
C9, C10	8	Dual 10 mfd cond.
C11	9	.01 mfd cond.
C12	9	.01 mfd cond.
L1	54	Audio choke
L2, L3	55	Line filter
LABC	56	Low frequency coils
LDE	57	Middle frequency coils
LFG	58	High frequency coils
P1	59	1000 ohm 250K dual pot.
PT1	60	Power transformer
R1	61	22K ohm 1/2 watt
R2	62	510 ohm 1/2 watt
R3	63	1 meg 1/2 watt
R4	64	22K ohm 1/2 watt
R5	65	68K ohm 1/2 watt
R6	66	10K ohm 1/2 watt
R7	67	1000 ohm 1/2 watt
R8	67	1000 ohm 1/2 watt
R9	67	1000 ohm 1/2 watt
R10	67	1000 ohm 1/2 watt
R11	66	1000 ohm 1/2 watt
R12	67	1000 ohm 1/2 watt
R13	68	6K ohms, 10 watt
R14	69	1K ohms, 1 watt
S1	70	2P-6pos. switch
S2	71	2P-3pos. switch
S3	72	1P-4pos. switch
S4	73	SPST switch
V1	76	6C4 tube
V2	77	6SL7 tube
V3	78	VR150 tube
V4	79	6X5 tube

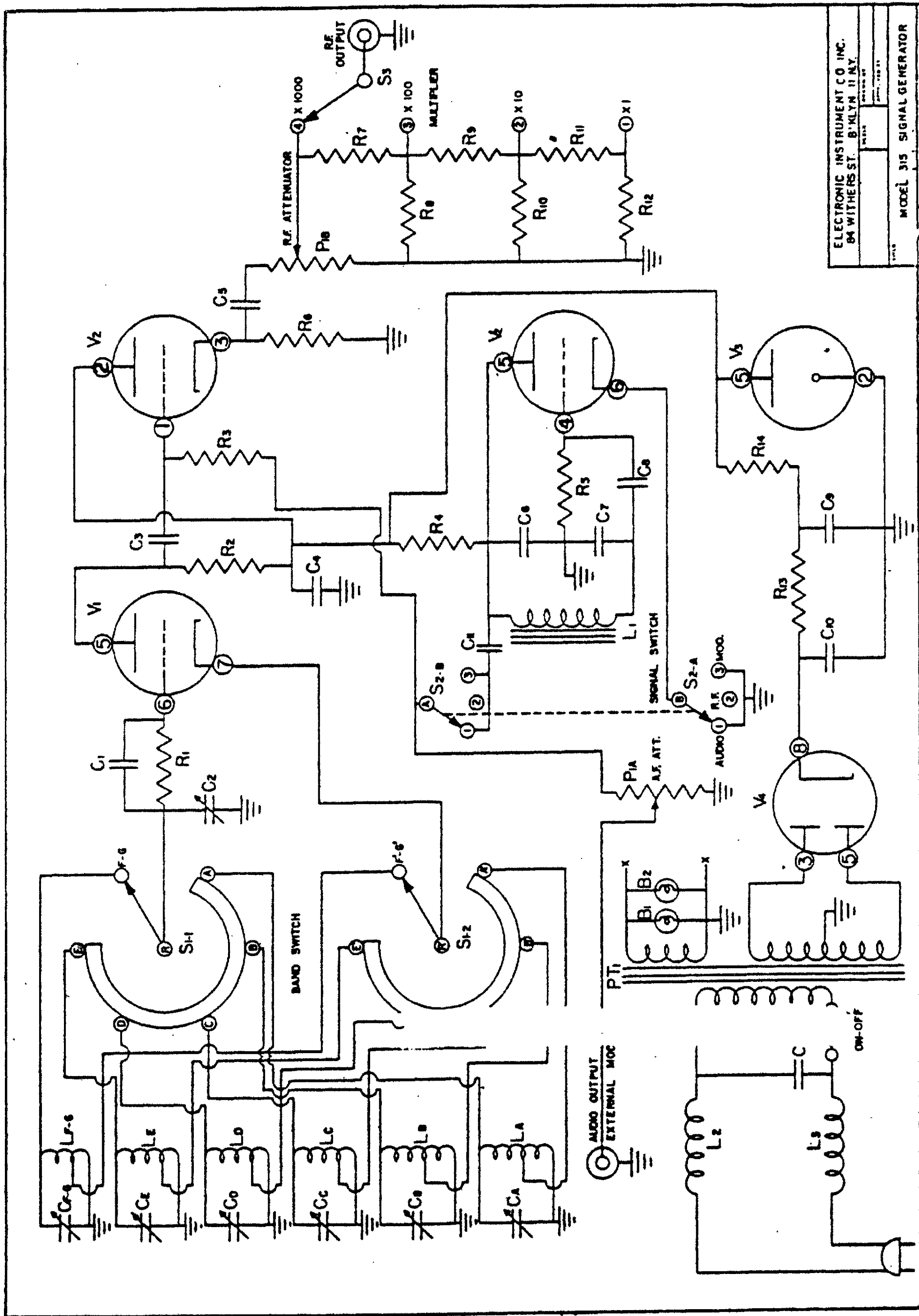

ELECTRONIC INSTRUMENT CO. INC.
 84 WITHERS ST. BAYLOR, N.Y.
 MODEL 315 SIGNAL GENERATOR

MODEL 315 RESISTANCE CHART

	PIN 1	PIN 2	PIN 3	PIN 4	PIN 5	PIN 6	PIN 7	PIN 8
V1 - 6C4	-	1K	*0	0	1.6K	22K	0	
V2 - 6SL7	1.25M	1K	10K	68K	23K	-	*0	0
V3 - VR150	-	0	0	-	1K	-	0	-
V4 - 6X5	0	0	150Ω	-	150Ω	-	*0	0

1. All resistance measurements taken with VTVM and chassis as ground.
2. Measurements made with C9 and C10 shorted to ground, multiplier switch at X1000, attenuator pot to MAX., band switch at F, G, band and signal switch at RF.
3. Readings are ±20% or 30%.

* Resistance too small to measure accurately.

MODEL 315 VOLTAGE CHART

	PIN 1	PIN 2	PIN 3	PIN 4	PIN 5	PIN 6	PIN 7	PIN 8
V1 - 6C4	-	140V	6.3 VAC	0	135V	-.6V	0	
V2 - 6SL7	.4 VAC	140V	4V	**0	138V	-	6.3 VAC	0
V3 - VR150	-	0	175V	-	150V	-	175V	-
V4 - 6X5	0	0	275 VAC	-	275 VAC	-	6.3 VAC	350V

1. All voltage measurements taken with VTVM and chassis as ground.
 2. Measurements taken with multiplier switch at X1000, attenuator pot to MAX., band switch at F, G, band and signal switch at RF.
- Readings are ± 20% or 30%.

** When signal switch is on AUD. or MOD. there is 1.4 VAC.

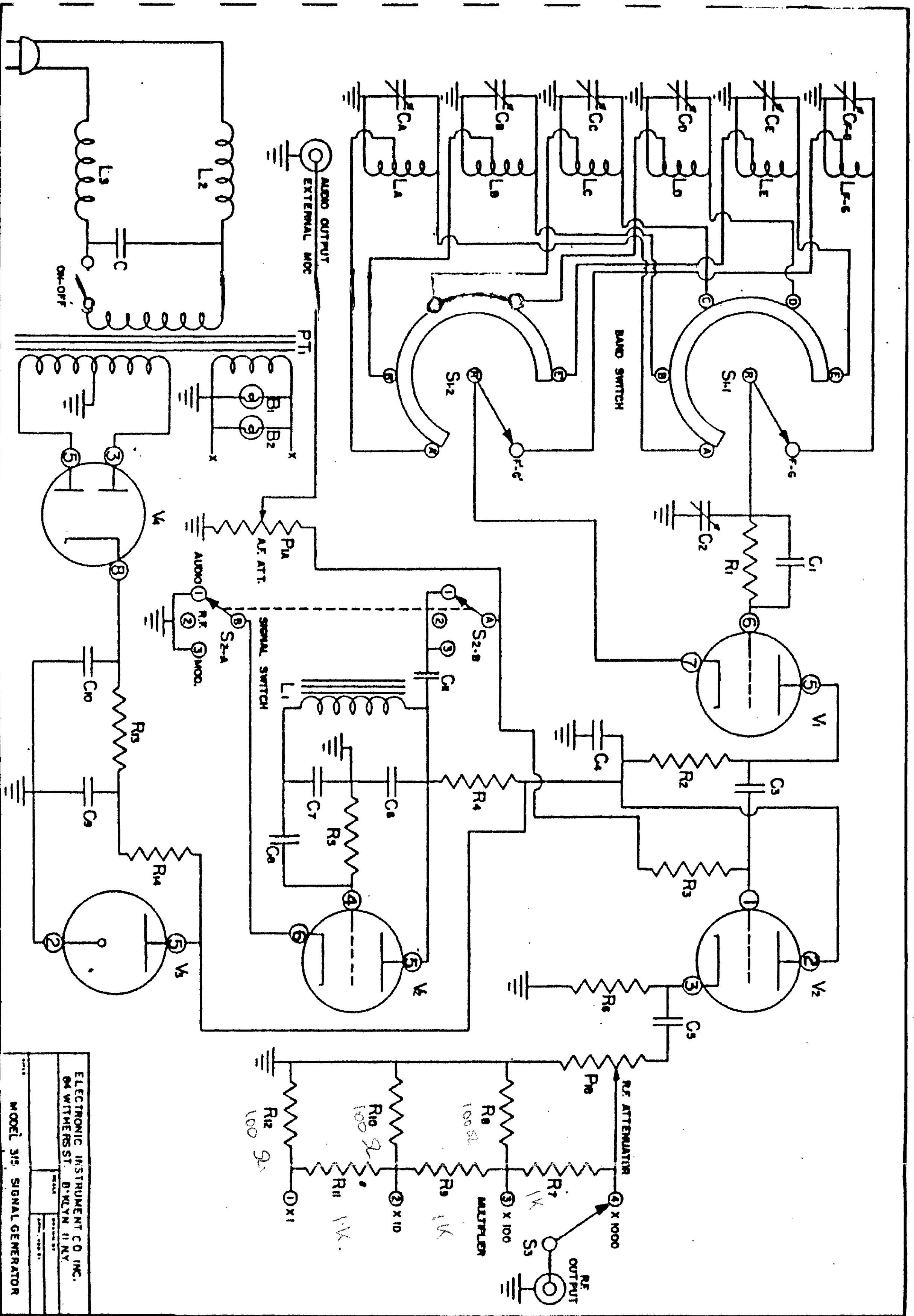

ELECTRONIC INSTRUMENT CO INC.
 64 WITHEBS ST. B-KLYN 11 NY.
 MODEL 319 SIGNAL GENERATOR

SYMBOL	PART #	SPECIFICATION
B1	1	#47 bulb
B2	1	#47 bulb
C1	2	100 nmfd cond.
C2	3	Main tuning cond.
C3	2	100 mmfd cond.
C4	4	.05 mfd cond.
C5	5	.001 mfd cond.
C6	6	.25 mfd cond.
C7	7	.5 mfd cond.
C8	4	.05 mfd cond.
C9,C10	8	Dual 10 mfd cond.
C11	9	.01 mfd cond.
C12	9	.01 mfd cond.
L1	54	Audio choke
L2,L3	55	Line filter
LABC	56	Low frequency coils
LDE	57	Middle frequency coils
LFG	58	High frequency coils
P1	59	1000 ohm 250K dual pot.
PT1	60	Power transformer
R1	61	22K ohm 1/2 watt
R2	62	510 ohm 1/2 watt
R3	63	1 meg 1/2 watt
R4	61	22K ohm 1/2 watt
R5	64	68K ohm 1/2 watt
R6	65	10K ohm 1/2 watt
R7	66	1000 ohm 1/2 watt
R8	67	100 ohm 1/2 watt
R9	66	1000 ohm 1/2 watt
R10	67	100 ohm 1/2 watt
R11	66	1000 ohm 1/2 watt
R12	67	100 ohm 1/2 watt
R13	68	6K ohms, 10 watt
R14	69	1K ohms, 1 watt
S1	70	2P-6Pos. switch
S2	71	2P-3Pos. switch
S3	72	1P-4Pos. switch
S4	73	SPST switch
V1	76	6C4 tube
V2	77	6SL7 tube
V3	78	VR150 tube
V4	79	6X5 tube